

**S6D06065A/S6D06065F/S6D06065E/S6D06065G/S6D06065I**  
**6A 650V SIC POWER SCHOTTKY RECTIFIERS**

**Description**





This 650V 6A diode is a high voltage Schottky rectifier that has very low total conduction losses and very stable switching characteristics over temperature extremes. The S6D06065A/S6D06065F/S6D06065E/S6D06065G/S6D06065I are ideal for energy sensitive, high frequency applications in challenging environments.

**Features**

- 175°C T<sub>J</sub> operation
- Ultra-low switching loss
- Switching speeds independent of operating temperature
- Low total conduction losses
- High forward surge current capability
- High package isolation voltage
- Terminals finish: 100% Pure Tin
- “-A” is an AEC-Q101 qualified device
- Pb – Free Device
- All SMC parts are traceable to the wafer lot
- Additional electrical and life testing can be performed upon request

**Applications**

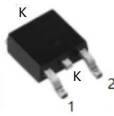
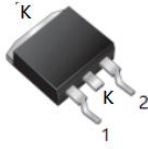
- Alternative energy inverters
- Power Factor Correction (PFC)
- Free-Wheeling diodes
- Switching supply output rectification
- Reverse polarity protection[2]

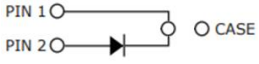
<p>S6D06065A</p> 	<p>S6D06065F</p> 	<p>S6D06065E</p> 	<p>S6D06065G</p> 	<p>S6D06065I</p> 
<p>TO-220AC (TO-220-2)</p>	<p>ITO-220AC (TO-220-F2)</p>	<p>DPAK (TO-252-2)</p>	<p>D<sup>2</sup>PAK (TO-263-2)</p>	<p>TO-220-Isolation</p>
				

### Maximum Ratings:

Characteristics	Symbol	Condition	Max.	Units
Peak Repetitive Reverse Voltage Working Peak Reverse Voltage DC Blocking Voltage	$V_{RRM}$ $V_{RWM}$ $V_{DC}$	-	650	V
Average Rectified Forward Current	$I_{F(AV)1}$	$T_C=25^{\circ}C$	25	A
	$I_{F(AV)2}$	$T_C=136^{\circ}C$	10	A
	$I_{F(AV)3}$	$T_C=157^{\circ}C$	6	A
Repetitive Peak Forward Surge Current	$I_{FRM1}$	10ms, Half Sine pulse, $T_C=25^{\circ}C$	31	A
	$I_{FRM2}$	10ms, Half Sine pulse, $T_C=110^{\circ}C$	27	A
Peak One Cycle Non-Repetitive Surge Current	$I_{FSM1}$	10ms, Half Sine pulse, $T_C=25^{\circ}C$	52	A
	$I_{FSM2}$	10ms, Half Sine pulse, $T_C=110^{\circ}C$	46	A
Non-Repetitive Peak Forward Surge Current	$I_{F,Max1}$	10 $\mu$ s. Pulse, $T_C=25^{\circ}C$	520	A
	$I_{F,Max2}$	10 $\mu$ s. Pulse, $T_C=110^{\circ}C$	470	A
Power Dissipation	$P_{tot1}$	$T_C=25^{\circ}C$	88	W
	$P_{tot2}$	$T_C=110^{\circ}C$	35	W
TO-220 Mounting Torque		M3 Screw	1	Nm
		6-32 Screw	8.8	bf-in

### Electrical Characteristics:

Characteristics	Symbol	Condition	Typ.	Max.	Units
Forward Voltage Drop*	V <sub>F1</sub>	@ 6A, Pulse, T <sub>J</sub> = 25 °C	1.27	1.5	V
	V <sub>F2</sub>	@ 6A, Pulse, T <sub>J</sub> = 175 °C	1.4	1.6	V
Reverse Current*	I <sub>R1</sub>	@V <sub>R</sub> = rated V <sub>R</sub> T <sub>J</sub> = 25 °C	0.3	3	µA
	I <sub>R2</sub>	@V <sub>R</sub> = rated V <sub>R</sub> T <sub>J</sub> = 175 °C	6	25	µA
Junction Capacitance	C <sub>T</sub>	V <sub>R</sub> =0V, T <sub>J</sub> =25°C, f=1MHz	559	-	pF
Reverse Recovery Charge	Q <sub>c</sub>	I <sub>F</sub> = 6A, di/dt = 200A/µs V <sub>R</sub> = 400 V, T <sub>J</sub> = 25°C	34.87	-	nC
Capacitance Stored Energy	E <sub>c</sub>	V <sub>R</sub> = 400 V, T <sub>J</sub> = 25°C	8.54	-	µJ

\* Pulse width < 300 µs, duty cycle < 2%

### Thermal-Mechanical Specifications:

Characteristics	Symbol	S6D06065A	S6D06065F	S6D06065E	S6D06065G	S6D06065I	Units
Junction Temperature	T <sub>J</sub>	-55 to +175					°C
Storage Temperature	T <sub>stg</sub>	-55 to +175					°C
Typical Thermal Resistance Junction to Case	R <sub>θJC</sub>	1.7	4	1.5	1.65	3.3	°C/W

### Ordering Information

Device	Package	Shipping
S6D06065A	TO-220AC(TO-220-2)	50pcs / tube
S6D06065F	ITO-220AC(TO-220-F2)	50pcs / tube
S6D06065E	DPAK(TO-252-2)	2500pcs / reel
S6D06065ETR	DPAK(TO-252-2)	2500pcs / reel
S6D06065G	D2PAK(TO-263-2)	800pcs / reel
S6D06065GTR	D2PAK(TO-263-2)	800pcs / reel
S6D06065I	TO-220-Isolation	50pcs / tube

For information on tape and reel specifications, including part orientation and tape sizes, please refer to our tape and reel packaging specification.

**Ratings and Characteristics Curves**

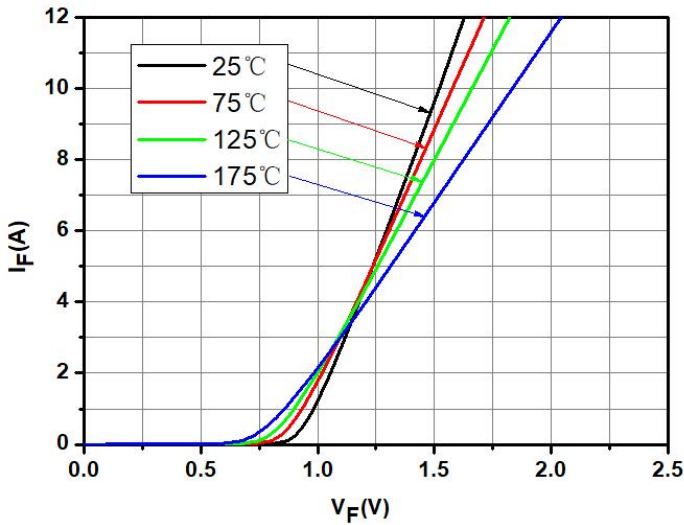

Fig.1-Typical Forward Voltage Characteristics

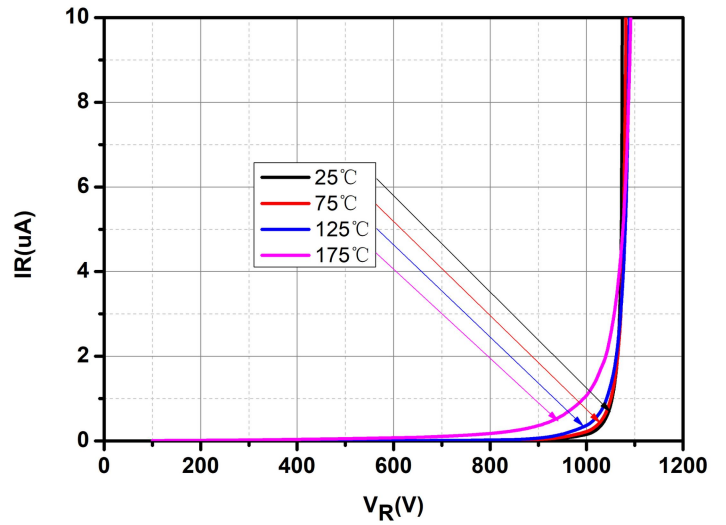

Fig.2-Typical Reverse Characteristics

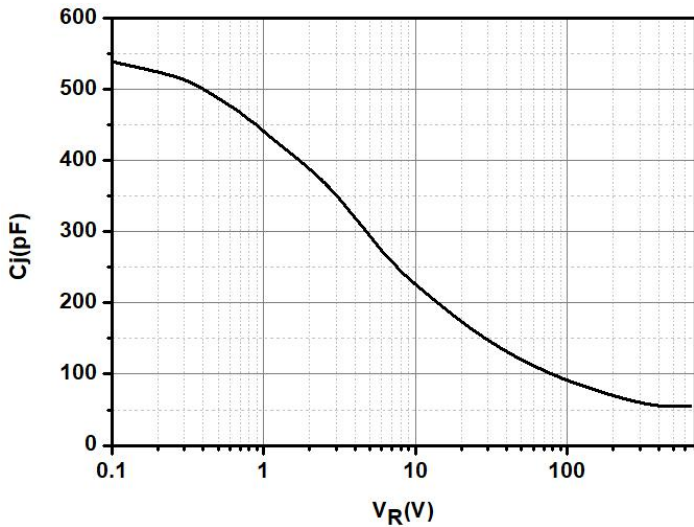

Fig.3-Capacitance vs. Reverse Voltage

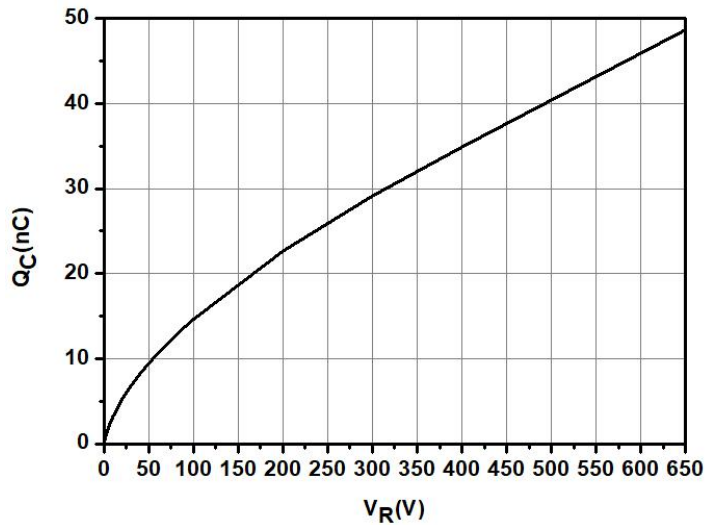

Fig.4-Total Capacitance Charge vs. Reverse Voltage

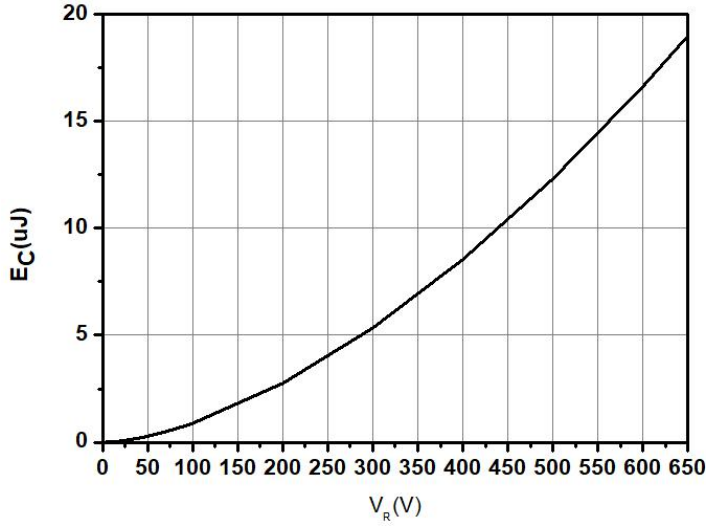

Fig.5-Capacitance Stored Energy

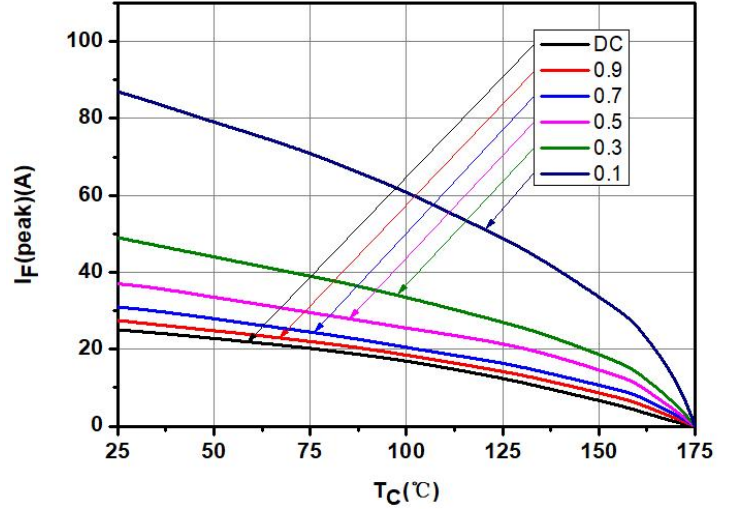

Fig.6-Current Derating

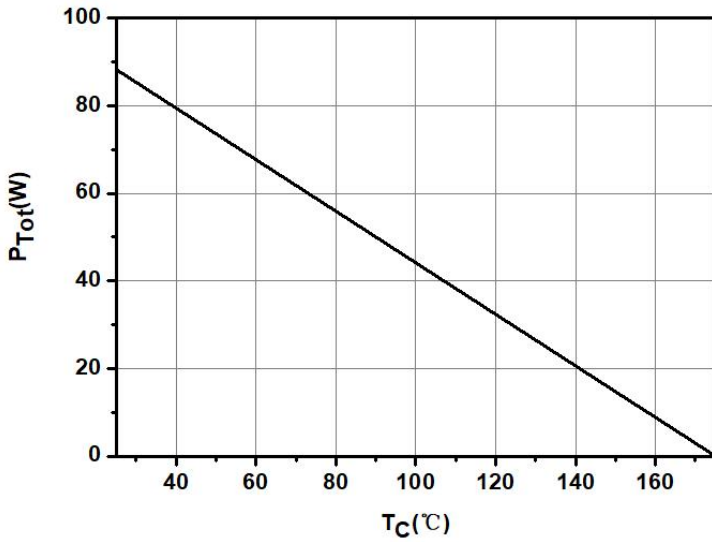
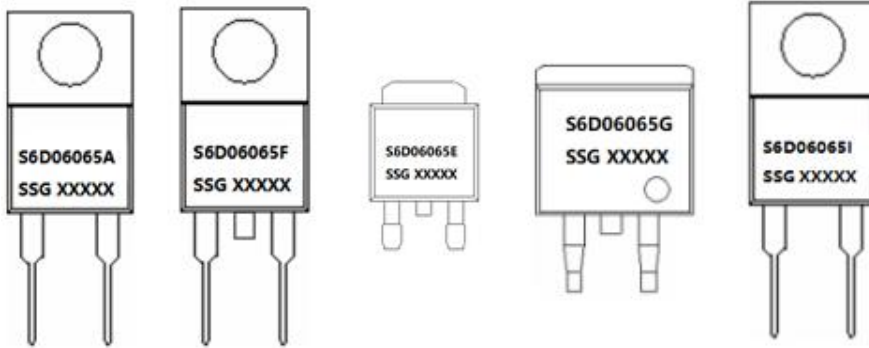

Fig.7-Power Derating

## Marking Diagram



Where XXXXX is YYWWL

S6D = Device Type  
A/F/E/G/I = Package type  
06 = Forward Current (6A)  
065 = Reverse Voltage (650V)  
SSG = SSG  
YY = Year  
WW = Week  
L = Lot Number

**Cautions:** Molding resin  
Epoxy resin UL:94V-0

## Tube Specification(TO-220-2/TO-220-F2/TO-220-Isolation)

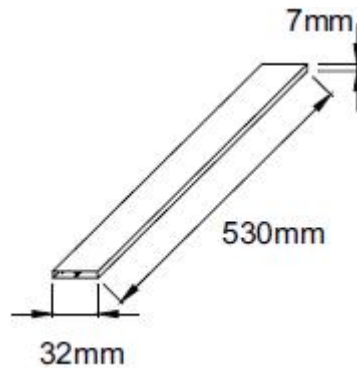

## Carrier Tape & Reel Specification DPAK(TO-252-2)

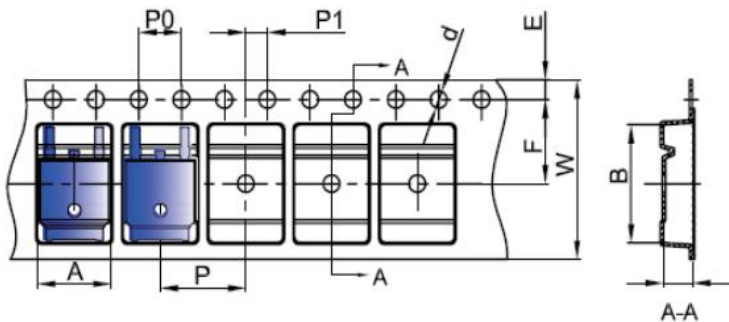

SYMBOL	Millimeters	
	Min.	Max.
A	6.80	7.00
B	10.40	10.60
C	2.60	2.80
d	Φ1.45	Φ1.65
E	1.65	1.85
F	7.40	7.60
P0	3.90	4.10
P	7.90	8.10
P1	1.90	2.10
W	15.90	16.30

**Carrier Tape & Reel Specification D2PAK(TO-263-2)**

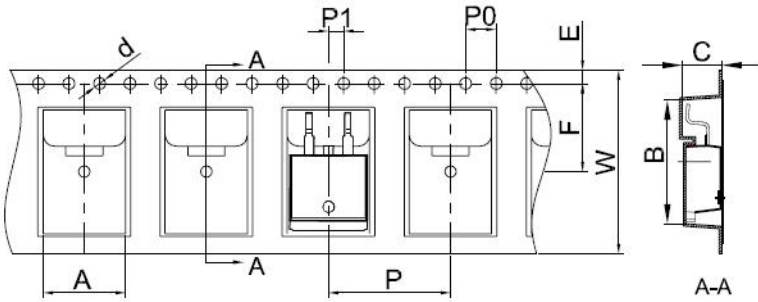

SYMBOL	Millimeters	
	Min.	Max.
A	10.70	10.90
B	16.03	16.23
C	5.11	5.31
d	1.45	1.65
E	1.65	1.85
F	11.40	11.60
P0	3.90	4.10
P	15.90	16.10
P1	1.90	2.10
W	23.90	24.30

**Mechanical Dimensions TO-220AC(TO-220-2)**

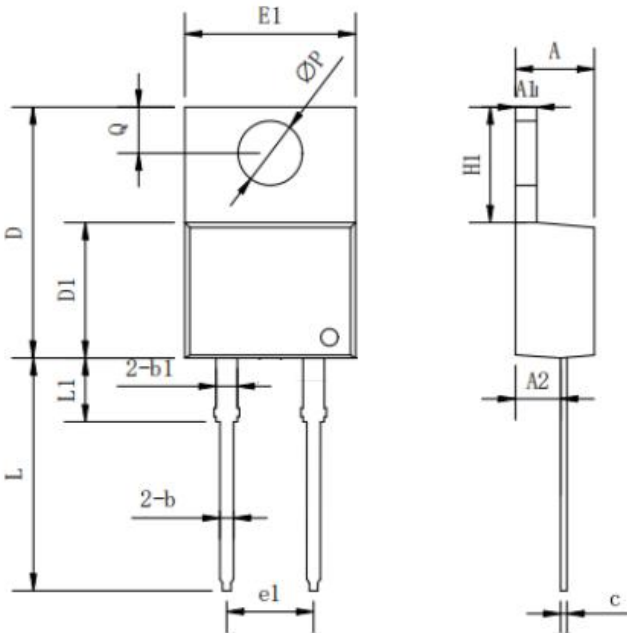

Symbol	Dimensions in millimeters		
	Min.	Typical	Max.
A	3.56	-	4.83
A1	0.51	-	1.40
A2	2.03	-	2.92
b	0.38	-	1.02
b1	1.14	-	1.78
c	0.31	-	0.61
D	14.22	-	16.51
D1	8.38	-	9.42
E1	9.65	10.16	10.67
e1	-	5.08	-
H1	5.84	-	6.86
L	12.70	-	14.73
L1	-	-	6.35
ΦP	-	3.56	-
Q	2.54	-	3.43



**Mechanical Dimensions ITO-220AC(TO-220-2F)**

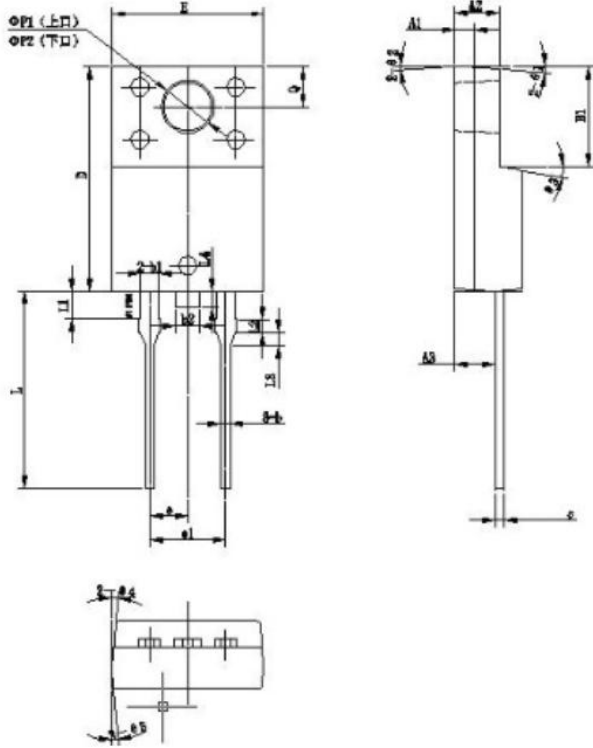

Symbol	Dimensions in millimeters		
	Min.	Typical	Max.
A	4.30	4.0	4.70
A1		1.30	
A2	2.80	3.00	3.20
A3	2.50	2.70	2.90
b	0.5	0.6	0.75
b1		1.20	
b2		1.60	
e	0.55	0.6	0.75
D	14.80	15.00	15.20
E	8.96	10.14	10.36
e		2.55	
e1		5.10	
H1	8.50	8.70	8.90
L	17.70	18.20	18.70
L1		1.80	
L2		1.00	
L3		0.80	
L4		1.10	
$\Phi P1$ (上口)	3.30	3.50	3.70
$\Phi P1$ (下口)	2.99	3.19	3.39
Q	2.50	2.70	2.90
$\Theta 1$		5°	
$\Theta 2$		4°	
$\Theta 3$		10°	
$\Theta 4$		5°	
$\Theta 5$		5°	

**Mechanical Dimensions DPAK(TO-252-2)**

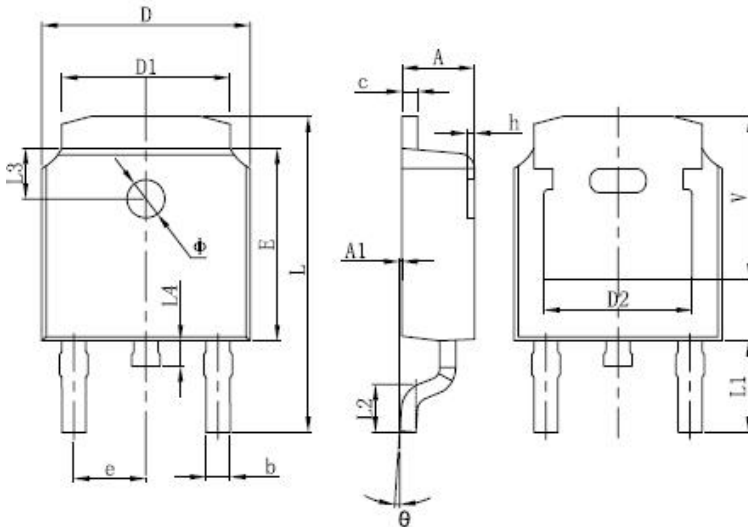

SYMBOL	Dimensions in millimeters		
	Min.	Typ.	Max.
A	2.18	-	2.39
A1	-	-	0.13
b	0.64	-	0.89
c	0.46	-	0.89
D	6.35	-	6.73
D1	4.95	-	5.46
D2	4.32	-	-
E	5.97	6.10	6.22
e	2.29BSC		
L	9.40	-	10.41
L1	2.90 REF.		
L2	1.40	1.52	1.78
L4	-	-	1.02
$\Phi$	1.1	-	1.3
$\Theta$	0°	-	10°
V	5.21	-	-



### Mechanical Dimensions D<sup>2</sup>PAK(TO-263-2)

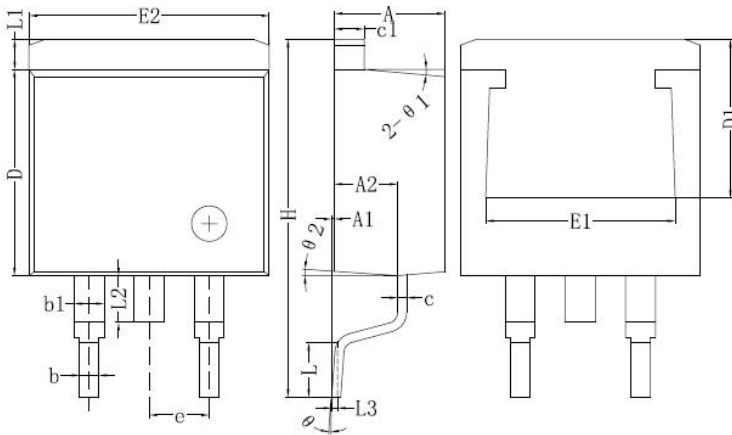

Symbol	Dimensions in millimeters	
	Min.	Max.
A	4.06	4.83
A1	0	0.26
b	0.51	0.99
b1	1.14	1.78
c	0.31	0.74
c1	1.14	1.65
D	8.38	9.65
D1	6.4	
E1	6.22	
E2	9.65	10.67
e	2.54BSC	
H	14.6	15.88
L	1.78	2.8
L1	-	1.68
L2	-	2.2
L3	0.255BSC	
Θ	0	8°

### Mechanical Dimensions TO-220-Isolation

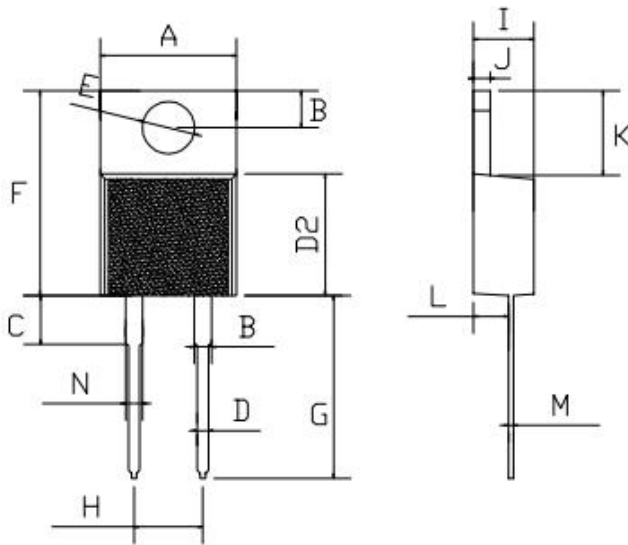

SYMBOL	Millimeters		Inches	
	Min.	Max.	Min.	Max.
A	9.7	10.4	0.381	0.409
B	2.5	3.0	0.098	0.118
C	3.5	3.9	0.137	0.153
D	0.7	0.92	0.027	0.036
E	3.72	3.95	0.146	0.155
F	14.51	15.55	0.571	0.612
G	12.95	13.9	0.509	0.547
H	4.95	5.19	0.194	0.204
I	4.38	4.65	0.172	0.183
J	1.15	1.36	0.045	0.053
K	5.86	6.38	0.230	0.251
L	2.35	2.85	0.092	0.112
M	0.32	0.58	0.012	0.022
N	1.18	1.42	0.046	0.055



S6D06065A  
S6D06065F  
S6D06065E  
S6D06065G  
S6D06065I

**Technical Data**  
**Data Sheet N2567, REV.-**



**DISCLAIMER:**

- 1- The information given herein, including the specifications and dimensions, is subject to change without prior notice to improve product characteristics. Before ordering, purchasers are advised to contact the SMC Diode Solutions sales department for the latest version of the datasheet(s).
- 2- In cases where extremely high reliability is required (such as use in nuclear power control, aerospace and aviation, traffic equipment, medical equipment, and safety equipment), safety should be ensured by using semiconductor devices that feature assured safety or by means of users' fail-safe precautions or other arrangement.
- 3- In no event shall SMC Diode Solutions be liable for any damages that may result from an accident or any other cause during operation of the user's units according to the datasheet(s). SMC Diode Solution assumes no responsibility for any intellectual property claims or any other problems that may result from applications of information, products or circuits described in the datasheets.
- 4- In no event shall SMC Diode Solutions be liable for any failure in a semiconductor device or any secondary damage resulting from use at a value exceeding the absolute maximum rating.
- 5- No license is granted by the datasheet(s) under any patents or other rights of any third party or SMC Diode Solutions.
- 6- The datasheet(s) may not be reproduced or duplicated, in any form, in whole or part, without the expressed written permission of SMC Diode Solutions.
- 7- The products (technologies) described in the datasheet(s) are not to be provided to any party whose purpose in their application will hinder maintenance of international peace and safety nor are they to be applied to that purpose by their direct purchasers or any third party. When exporting these products (technologies), the necessary procedures are to be taken in accordance with related laws and regulations..